

The case  
coders  
that  
change  
marking  
wheels  
with a

**“TWIST OF THE WRIST”**

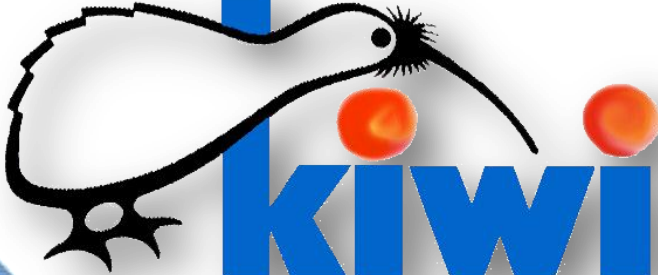

**kiwi**®  
[www.KiwiCoders.com](http://www.KiwiCoders.com)

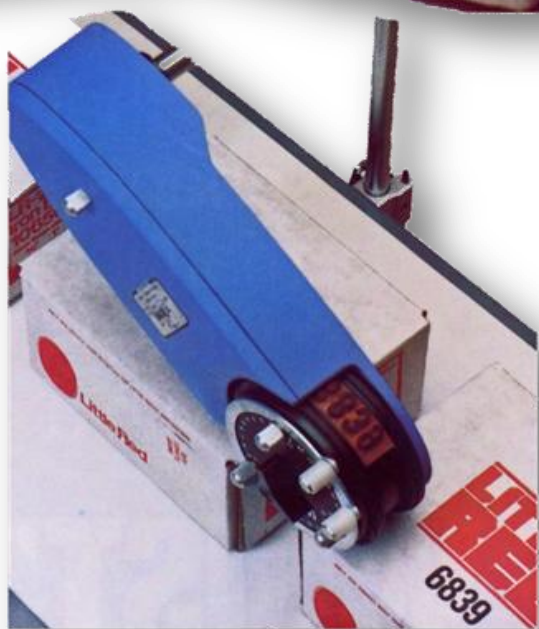
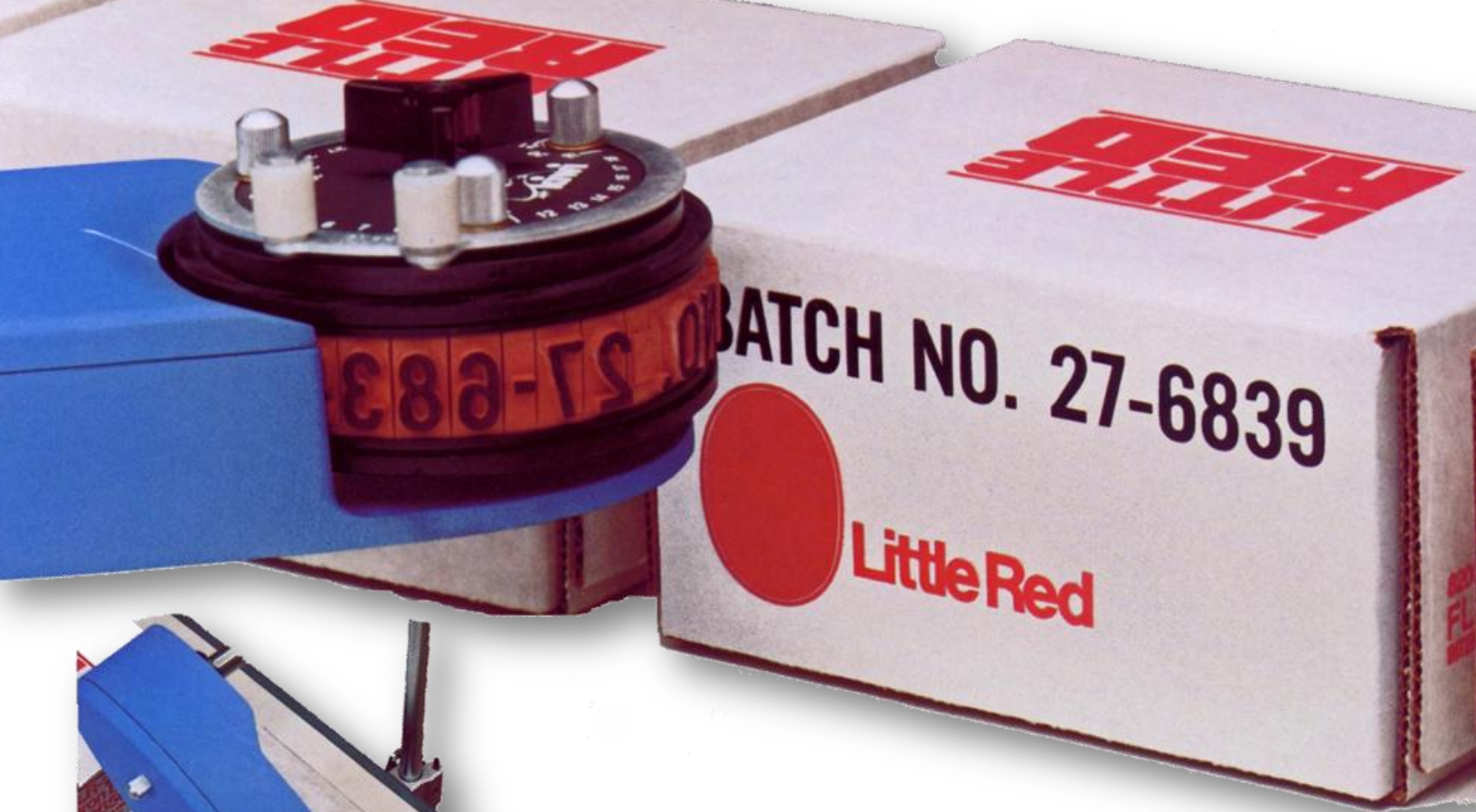

The Series 450 Coders form the basis for all the Orbit Series Coders described in this newsletter. Ruggedly built and easily installed, these coders incorporate a newly designed marking wheel which simplifies and speeds "on-the-fly" changes in imprint information. A simple twist of the locking knob allows the marking wheel to be removed quickly from the coder. Spare wheels- pre-set with new imprint data- can be mounted easily. A splined hub on the marking wheel allows rapid adjustment of imprint location in 1/4" increments without tools. These coders can be mounted above, below or alongside the conveyor line as required.

**Model 451**  
7/8" Max. Print height



**Model 452**  
2" Max. Print height



**Model 453**  
3 1/8" Max. Print height

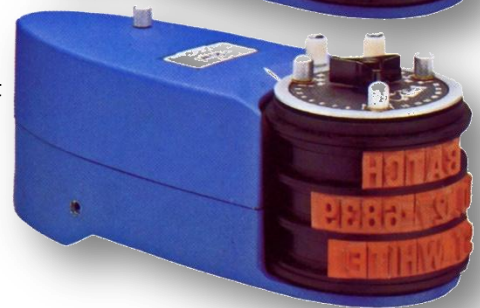

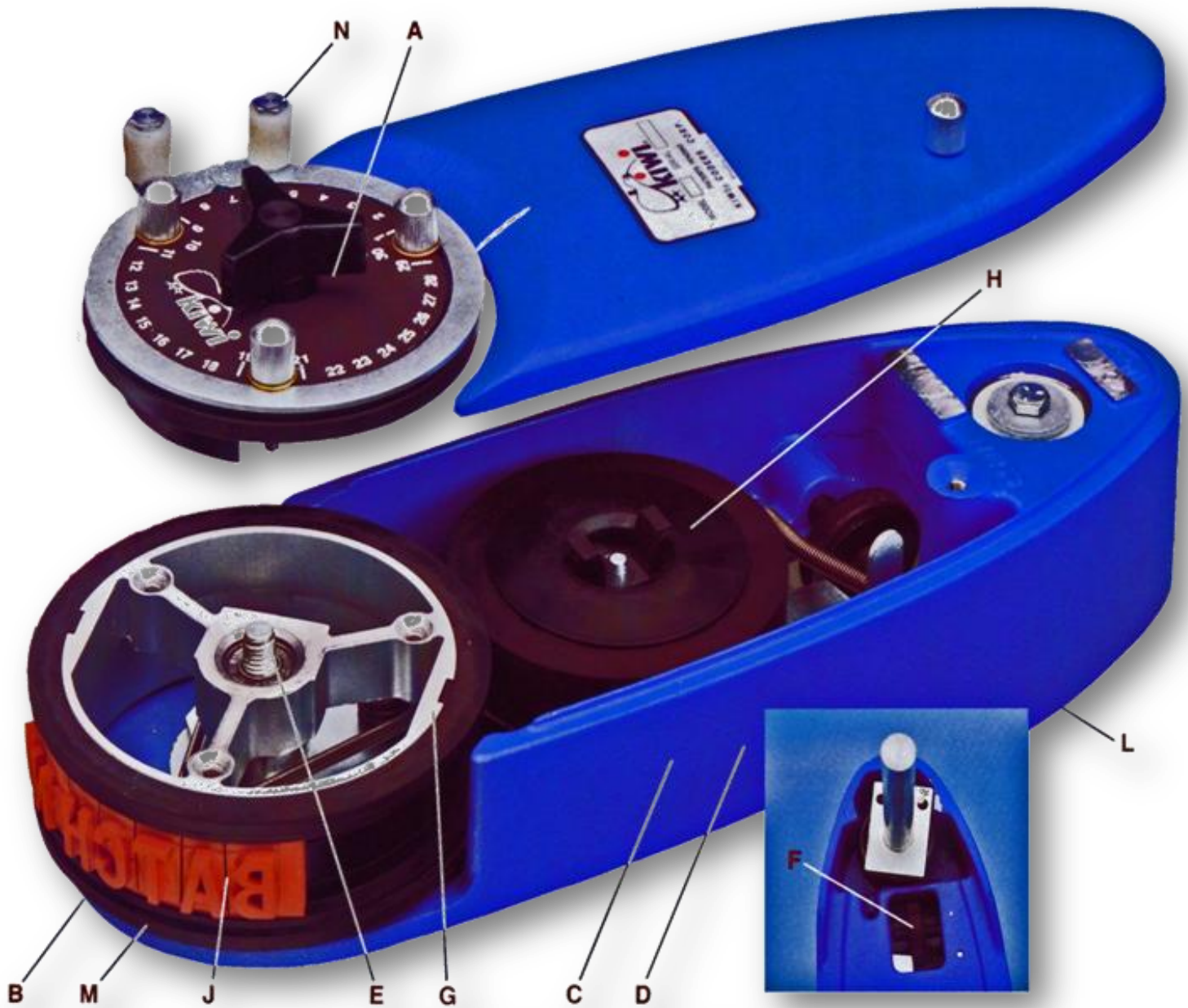

**A.** Marking wheel can be removed and replaced in seconds for quick message changes

**B.** Three models with print heights to  $\frac{7}{8}$ ", 2" (2 lines of  $\frac{7}{8}$ " type) or  $3\frac{1}{8}$ " (3 lines of  $\frac{7}{8}$ " type)

**C.** Heavy-duty cast metal housing provides protection against dust and dirt

**D.** Low profile allows printing within  $\frac{7}{8}$ " of case bottom

**E.** Splined hub on marking wheel allows easy, precise imprint relocation (registration) without tools

**F.** Knurled wheel allows fingertip adjustment of ink cartridge pressure; no tools required

**G.** Patented keyway slots on wheel and baselock and Channelok® type rings eliminate type shift during operation

**H.** Quick-change ink cartridge assembly with finger release lock. Eliminates ink-stained fingers.

**J.** Choice of 3 type systems: Kiwi Channelok, baselock or Kiwi printing mats

**K.** Coder swings out for easy change of type or ink cartridge. No tools required.

**L.** Quick and easy to install (only two mounting holes); easy change from right to left-hand mounting

**M.** Optional knurled metal drive tracks available for heavy-duty applications

**N.** Optional anti-repeat device delays marking wheel reset until case has passed.

# SERIES 460

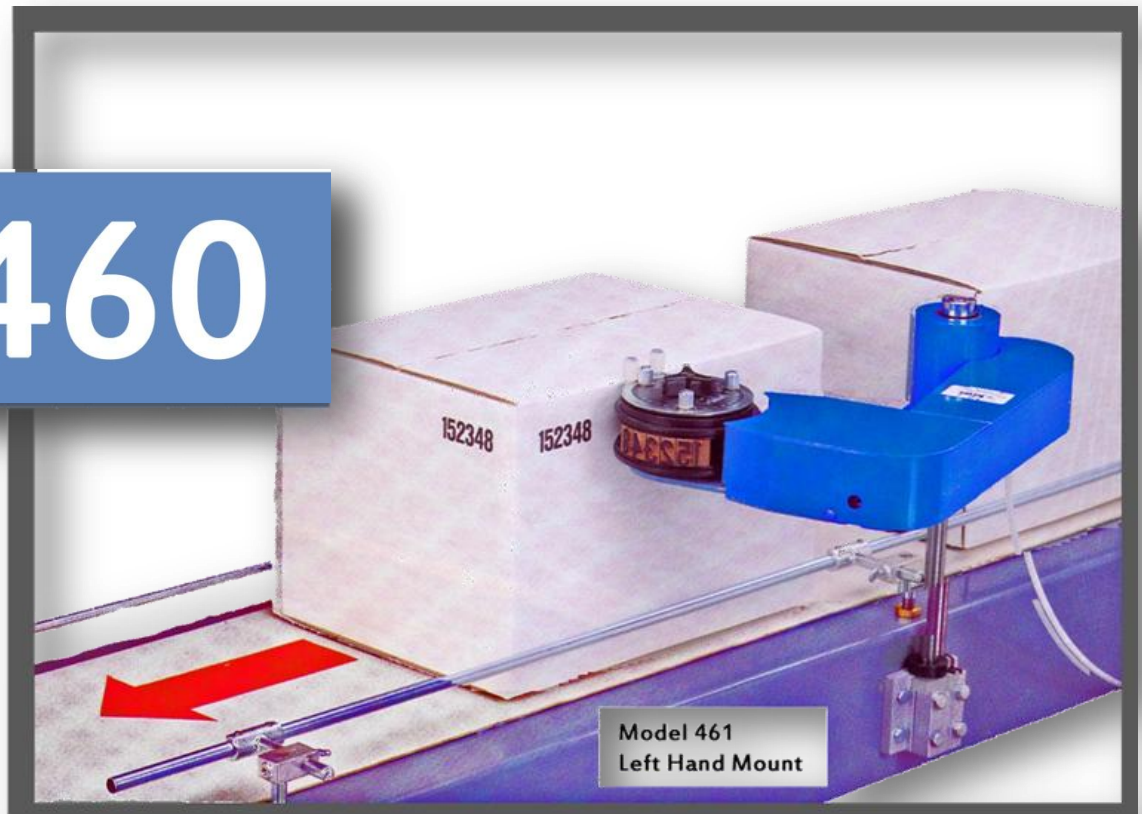

## **SERIES 460 FRONT AND SIDE CODERS**

Kiwi 460 Coders will automatically imprint coded information or product identification on the front panel and one adjacent side of filled cases. The unit is friction driven by the case itself and indexes after each imprint for positive print registration. An air cylinder provides variable imprint pressure and variable rate of return to print position. The use of an air cylinder instead of a spring offers several advantages, including ease of adjustment, wide adjustment range, uniform pressure throughout cycle and durability.

- **Three models:  $\frac{7}{8}$ " , 2" and  $3\frac{1}{8}$ " maximum print heights**
- **Low profile allows unit to fit into restricted spaces**
- **'Anti-repeat' feature ensures a single, registered imprint along with positive start of marking wheel. No smearing**
- **Air cylinder cushion provides smooth operation, variable imprint pressure**
- **Easy installation, few moving parts...needs little attention and a minimum of maintenance**
- **Incorporates all operating and convenience features of Series 450**



series **425**

## **MODEL 425 CONSECUTIVE CODER**

**For consecutive coding of filled cases.**  
This Kiwi Coder is used to apply sequential number codes for precise identification of filled cases. It will spot imprint a 7-digit code which ascends one digit at a time. Model 425 imprints 1/4" (6.5mm) high characters in a sequence from 1 to 9,999,999. Cases can be marked at speeds up to 35 units per minute.

The Kiwi Model 425 Consecutive Coder is designed for high volume, day-in, day-out operation. It is easy to install and requires minimum maintenance.

**7 Digits • 1/4" (6mm) Character Height**

**8333258    8333259    8333260**

# SPECIFICATIONS

## SERIES 450 & MODEL 425

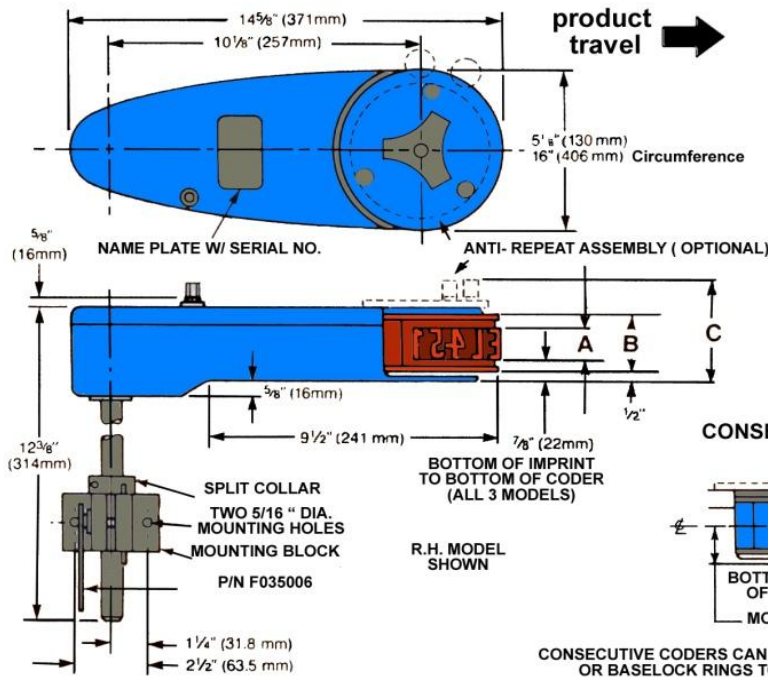

## MOUNTING DIMENSIONS

MODEL	A (mm)	B (mm)	C (mm)	NET WT. lbs. (kg)
451	7/8 (22)	1 5/8 (41)	3 1/2 (89)	10 (22)
452	2 (51)	2 3/4 (70)	4 5/8 (117)	11 (24)
453	3 1/8 (79)	3 7/8 (98)	5 3/4 (146)	12 (26)
425	1/4 (6.5)	3 7/8 (98)	5 3/4 (146)	13 (29)

- NOTES:**
- 1) STANDARD MODEL INCLUDES BASIC CODER WITH MARKING WHEEL MOUNTING SHAFT, MOUNTING BLOCK ONE INK CARTRIDGE AND INSTRUCTIONS
  - 2) 8" MINIMUM LENGTH FOR REGISTERED IMPRINTS. FOR SHORTER CASES SPECIFY TWO WAY TIMER OPTION.
  - 3) MAXIMUM IMPRINT LENGTH: 12"

### CONSECUTIVE CODER MARKING WHEEL

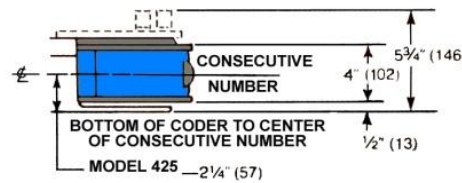

CONSECUTIVE CODERS CAN BE FURNISHED WITH KIWII CHANNELOK OR BASELOCK RINGS TO PROVIDE ADDITIONAL IMPRINTS.

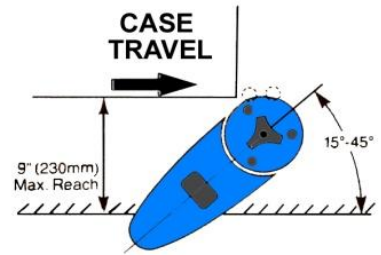

## SERIES 460

MINIMUM CASE SIZE: 7" RUNNING LENGTH  
 MINIMUM SPACE BETWEEN CASES: 10" NOMINAL (DEPENDS ON CONVEYOR SPEED)  
 MINIMUM CASE WEIGHT- NONE IN CASE SEALER  
 20LBS ( 9.1 Kg) ON RUFFTOP BELT CONVEYOR

MAXIMUM SPEED- 25 CASES/ MIN.  
 AIR SUPPLY - 60 PSI LINE PRESSURE  
 AIR CONSUMPTION- NEGLIGIBLE

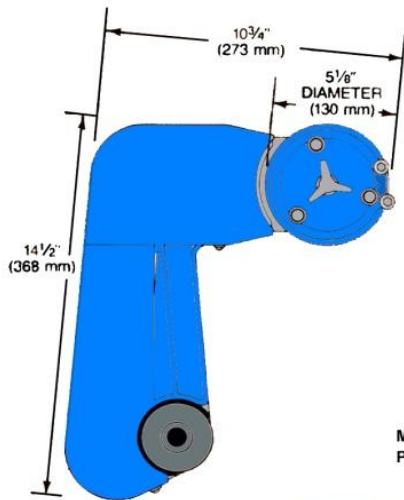

**NOTE:** STANDARD MODEL INCLUDES BASIC CODER WITH MARKING WHEEL, MOUNTING SHAFT, MOUNTING BLOCK, AIR CYLINDER, AIR FILTER AND REGULATOR, ONE INK CARTRIDGE AND INSTRUCTIONS.  
 Series 460 Coders require two type insertions in the marking wheel, one for each panel being coded.

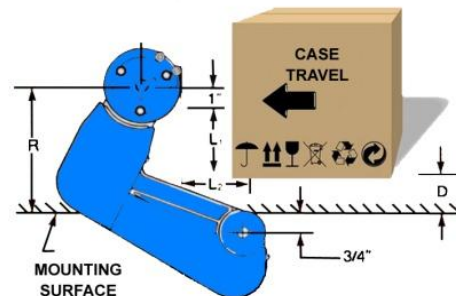

### MOUNTING DIMENSIONS

MODEL	A (mm)	B (mm)	NET WT. lbs. (kg)
461	7/8 (22)	3 3/4 (96)	15 (6.8)
462	2 (51)	4 7/8 (124)	15 1/2 (7.0)
463	3 1/8 (79)	6 (153)	16 (7.3)

### 460 FRONT & SIDE CODER

D	L <sub>1</sub>	L <sub>2</sub>	R
2"	6 1/4"	5 3/4"	9 1/4"
3	6	6	10
4	5	7	10
5	4	8	10
6	3	9	10
7	2	10	10

D= Distance from coder mounting surface to side of case.  
 L<sub>1</sub> = Maximum imprint length on the end panel.  
 L<sub>2</sub> = Maximum imprint length on side panel.  
 R= Maximum reach of marking wheel.  
**NOTE:** 1. Maximum imprint length. (L<sub>1</sub> & L<sub>2</sub>) = 12".  
 2. Minimum recommended D is 2".  
 3. Anti-repeat ass'y included.

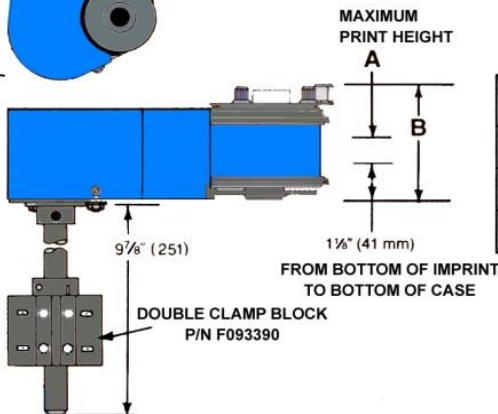

# INKING

# TYPE

# OPTIONS



Orbit Series Case Coders are available with a choice of three cartridge inking systems. The cartridge assembly snaps into place, and may be quickly removed and replaced.

**The K1 Ink Cartridge** is supplied pre-inked, providing more marking impressions and reduced printing costs. Requires fewer cartridge changes. Available in black, red, green and blue. Recommended for Models 451, 461 and 481.

**The K7 Ink Cartridge** is Kiwi's premium quality, long life pre-inking cartridge. Can be used as a throw-away or reinked with Kiwi No. 3 Ink (absorbent surfaces) or Kiwi No. 875 Ink (semi-absorbent surfaces). Available in black, red, green or blue. Recommended for all models.

**The K6 Ink Cartridge** is recommended

**Kiwi Channelok D Type** (standard) Deep cut characters provide excellent print definition. Available in individual characters and in strips containing full words or messages. Molded plastic channels hold type securely, allow type changes without loosening or removal of rings. Spacer rings accommodate type body sizes from 1/2" to 1 1/2".



**Baselock Type** (optional) Molded characters provide clear print definition. Use individual characters or complete words and slogans. Molded plastic baselock rings lock type securely.

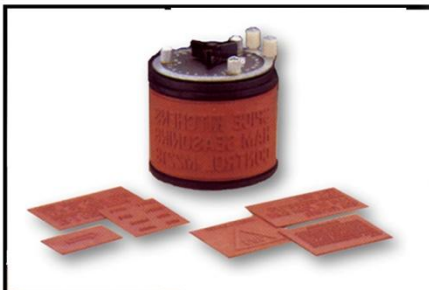

**Kiwi Magflex Magnetic Backed Mats** (optional). Quick change. Can be combined with Baselock and Channelok Type.

**Kiwi Adhesive-back Mats** (optional) Best suited for use with multi-line copy, company logotypes and designs. Type is mounted on a sleeve to allow installation and removal in one piece.

**Anti-Repeat Assembly Kit (No. F078152)** Provides precise imprint registration and/or prevents imprint repetition on cases longer than 16 in.

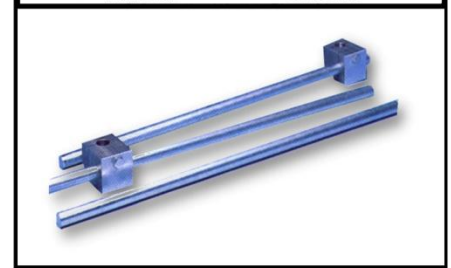
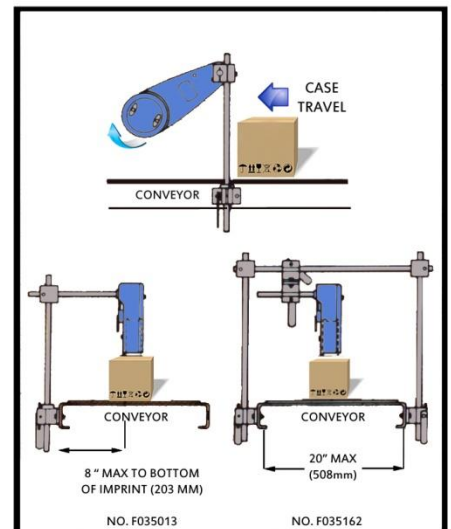

**Top-Mount Kit** Two styles are available: For overhangs up to 8 in. (No. FO35013), and overhangs exceeding 8 in. (No. FO 35162).

**Knurled Metal Drive Tracks (No. F078153)** For positive drive and long life in heavy duty applications. (Not shown)

**Two Way Timer (No. F037903)** Resets marking wheel every 1/2 revolution. Recommended for case lengths less than 8"; requires two type insertions. (Not shown.)



# CHANNELOK TYPE

# BASELOCK TYPE

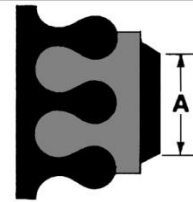
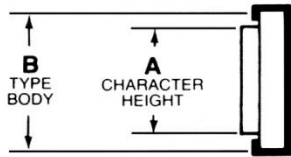

A (INCHES)	STYLE	B	APPROX. CHARACTERS PER INCH	ACTUAL SIZE
$\frac{3}{8}$	227D	$\frac{3}{4}$	4	<b>ABCDE</b>
$\frac{7}{16}$	228D	$\frac{3}{4}$	$3\frac{1}{2}$	<b>ABCDE</b>
$\frac{1}{2}$	229D	$\frac{3}{4}$	3	<b>ABCD</b>
$\frac{5}{8}$	230D	$\frac{3}{4}$	$2\frac{1}{2}$	<b>ABC</b>
$\frac{3}{4}$	231D	1	2	<b>ABC</b>
$\frac{7}{8}$	232D	1	2	<b>AB</b>
1	400D	$1\frac{1}{4}$	1	<b>AB</b>
$1\frac{5}{16}$	401D	$1\frac{1}{2}$	1	<b>A</b>

A (INCHES)	STYLE	APPROX. CHARACTERS PER INCH	ACTUAL SIZE
$\frac{1}{4}$	513	6	<b>BASE-LOCK</b>
$\frac{1}{4}$	513C	8	<b>BASE-LOCK</b>
$\frac{9}{32}$	514	5	<b>BASE-LOCK</b>
$\frac{3}{8}$	515	4	<b>BASE-LOCK</b>
$\frac{1}{2}$	516	3	<b>BASE-LOCK</b>
$\frac{5}{8}$	517	3	<b>BASE-LOCK</b>
$\frac{3}{4}$	518	3	<b>BASE-LOCK</b>
$\frac{7}{8}$	519	$2\frac{1}{2}$	<b>BASE-LOCK</b>

**NOTE:** ALL DIMENSIONS SHOWN IN INCHES.  
 OTHER TYPE STYLES AVAILABLE.  
 ASK FOR BULLETIN #191 (CHANNELOK) BULLETIN #160 (BASELOCK).

**KIWI CODERS CORPORATION**  
 265 EAST MESSNER DRIVE  
 WHEELING, IL 60090  
 (847) 541-4511

